



# Aging in Place:

Your Home, Your Community, Your Choice

A Workbook for Planning Your Future

Materials Compiled by

The Aging in Place Leadership Team of the New River Valley, Virginia



Back of cover page  
This page  
intentionally left  
blank

# TABLE OF CONTENTS

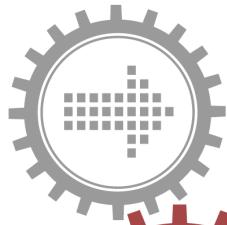

## Introduction & Background

- 2 The importance of planning for aging in place.
- 3 Structure of the workbook
- 4 Getting started



## Housing

- Will you be comfortable and safe in your home?
  - 7 Key Points
  - 8 Self-Assessment Questions
  - 18 Notes Page: Housing Questions, Considerations & Priorities
  - 19 Plan A/Plan B for Housing



## Health & Wellness

- Will you be able to address your health needs in your later years?
  - 21 Key Points
  - 22 Self-Assessment Questions
  - 33 Notes Page: Questions, Considerations & Priorities
  - 33 Plan A/Plan B for Health & Wellness



## Transportation

- Will You be able to get where you need to go safely and affordably?
  - 35 Key Points
  - 36 Self-Assessment Questions
  - 40 Notes Page: Questions, Considerations & Priorities
  - 41 Plan A/Plan B for Transportation

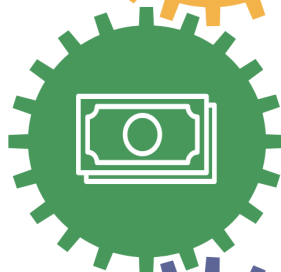

## Personal Finance

- Will you have sufficient financial resources as you get older?
  - 43 Key Points
  - 44 Self-Assessment Questions
  - 48 Notes Page: Questions, Considerations & Priorities
  - 49 Plan A/Plan B for Personal Finance



## Connection & Growth

- Will you have social and cultural opportunities that enrich your life?
  - 51 Key Points
  - 52 Self-Assessment Questions
  - 56 Notes Page: Questions, Considerations & Priorities
  - 57 Plan A/Plan B for Connection & Growth



## Additional Resources

- 59 Personal Plan Development Checklists
- 61 Important Documents Checklist & Locator
- 62 Budget Planning Worksheets
- 66 Seasonal Home Maintenance Checklists
- 70 Acknowledgements & Fair Use Notice

# THE IMPORTANCE OF PLANNING FOR AGING IN PLACE

Like the majority of older Americans, you may be intending to live in your current home for as long as possible. Your decision to *age in place* (that is, remain in your current home or community as you age) may seem like an obvious and logical choice. After all, you have invested time and money into your home and have fond memories of the time you have spent there with family and friends. Home not only connects us to people important to us, but can also give us a sense of place and belonging in our communities.

Aging in place in a safe and well-maintained home has many benefits. It helps improve personal health, social interactions, and connections to community resources. Living in a good home also enables us to enjoy a better quality of life. Yet, **aging in place is more than just planning to stay in your home.**

Aging in place requires an examination of different aspects of life beyond housing: health and well-being, finances, transportation, and social relationships. Even though many older Americans believe they will be able to manage changes that might occur in their health, wellbeing, and finances, **approximately 70% will require help with their care at some point, for an average of three years.** Thinking about your current *and* future potential needs and pre-planning for changes, including home modifications, can assist in maintaining your independence at home and will promote your ability to age in place.

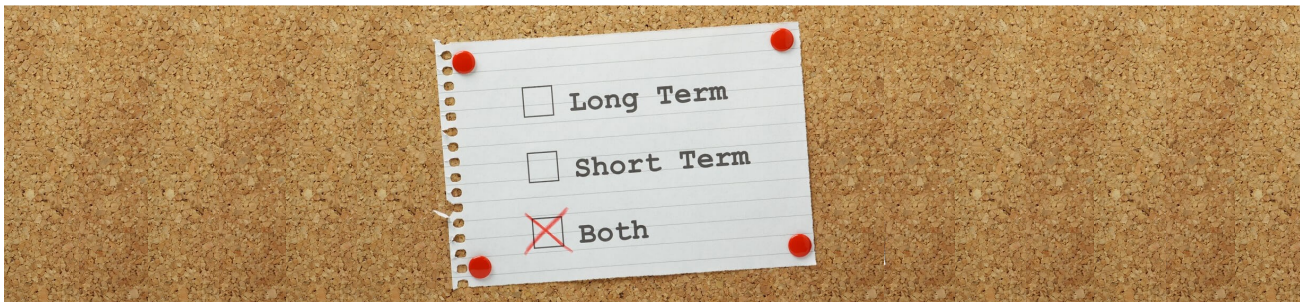

Deciding where and how to age in place requires more than just your intention. It should be part of a process that includes **personal reflection, conversations** with people important to you, **intentional planning,** and **action.**

Generally, the first step in holding conversations about aging in place is to **identify what you want and expect when it comes to where you will live.** Would you rather stay in your current home, move to a different place in your community, or move to an entirely new place? And does your budget align with these desires?

Once you have a better idea of where you want to live and what you can afford, you can start making a plan around those other critical elements. This planning workbook will help you think through all these aspects so that you can better determine how to stay active, healthy and happy as you age!

# STRUCTURE OF THE WORKBOOK

## STRUCTURE OF THE WORKBOOK: FIVE INTERRELATED TOPICS

This Aging In Place Workbook is built around five key topics which aging experts have identified as the critical factors that people should consider and plan for to successfully age in place. These include Housing, Health & Wellness, Transportation, Personal Finance, and Connection & Growth. As you consider each of the topics separately, it's also **important to consider how these topics can interrelate or impact one another.** Each chapter of the aging in place workbook follows the same format as follows:



### KEY POINTS

We have begun each chapter with three key points that are designed to expand your thinking from your current circumstances to what could potentially change for you in the future.

### SELF-ASSESSMENT QUESTIONS

Each chapter includes sets of questions that you can use to assess your current and potential future needs. Most of the questions require yes/no/not sure responses or will ask you to “check all that apply.” Other questions are open-ended to elicit a more detailed answer. There are no right or wrong answers.

### HIGHLIGHTED BOXES

You will also find additional information in “Did You Know” boxes in each chapter. These supplements relate directly to the questions in the chapter and offer additional context and/or resources for you: web addresses to online resources, and/or contact information for agencies and organizations that provide assistance or services for older adults.

### NOTES PAGES

This is a space for you to jot down anything that has come up for you as you worked through the self-assessment questions: Are there specific items you want to follow up on? New priorities? You may also want to use this space to note any questions you’ve answered with a “No” or “Not Sure.” These may highlight issues you should consider exploring further.

### PLAN A & PLAN B BY TOPIC AREA

At the close of each chapter we’ve provided a space for you to articulate your “Plan A,” your ideal scenario for that topic area, and your “Plan B,” your preferred alternative in the event your physical, cognitive, financial, and/or support circumstances change significantly. Use this page to list out, in concrete terms, the action items you intend to pursue going forward. The Plan A/Plan B page of each chapter can also serve as a jumping off point for important conversations you want to have with family and others in your support network.

## GETTING STARTED

***“A goal without a plan is just a wish.” - Antoine de Saint-Exupery***

This Workbook is designed to help you develop your own individualized plan to age in place. The materials included were adapted from respected aging in place resources including AARP, the National Aging in Place Council, and MetLife.



Each of the five focus areas contributes to overall success with aging in place and **should not be overlooked or left to chance**. Successful aging in place involves consideration and sound planning related to each of these themes.



## GETTING STARTED

Once you have completed this workbook, you should have a clearer picture of the factors you should consider and plan for to successfully age in place. If an event occurs in your future that alters your circumstances (a change in location, a financial gain or loss, a health issue, etc.), we recommend you revisit your plan to determine if you need to do some rethinking. **Alternatively, we strongly recommend that you use this workbook to explore several different ‘what if’ scenarios.** No one can definitely know the future, so it is always wise to plan for an array of possible circumstances; or, to amend a popular saying,

**“Hope for the best, plan for the worst, and prepare to be surprised.”**



Before you begin, set aside some uninterrupted time to familiarize yourself with the sections. Planning takes time and personal reflection. You are not expected to complete the workbook and make any final decisions in a single sitting. Feel free to save your responses, take a break, and come back to where you left off or start a new section.

**If you are married or have a partner, you can choose to fill out the workbook together or individually.** Some sections may be more useful if filled out separately followed by a conversation about how you both responded to the questions. You may also want to **involve other family, friends, or trusted advisors** at some point in this process. We recognize that these conversations are often perceived as difficult, but why not have fun with it?

Make it an occasion. Invite them to join you around the dining room table and answer the workbook questions together. Time to begin!

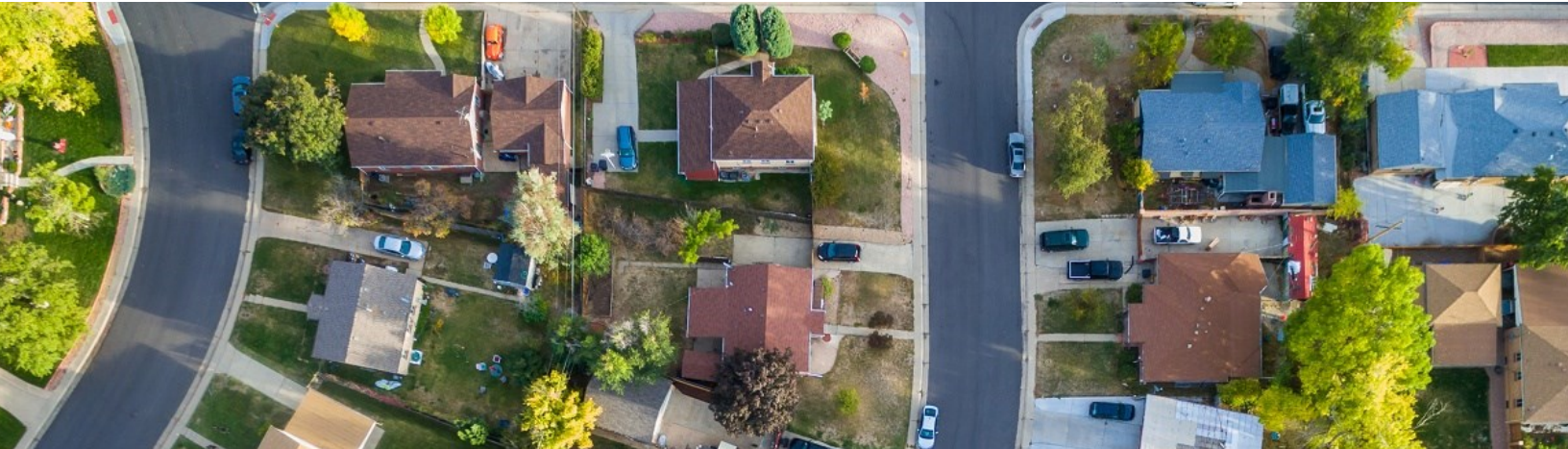

# HOUSING

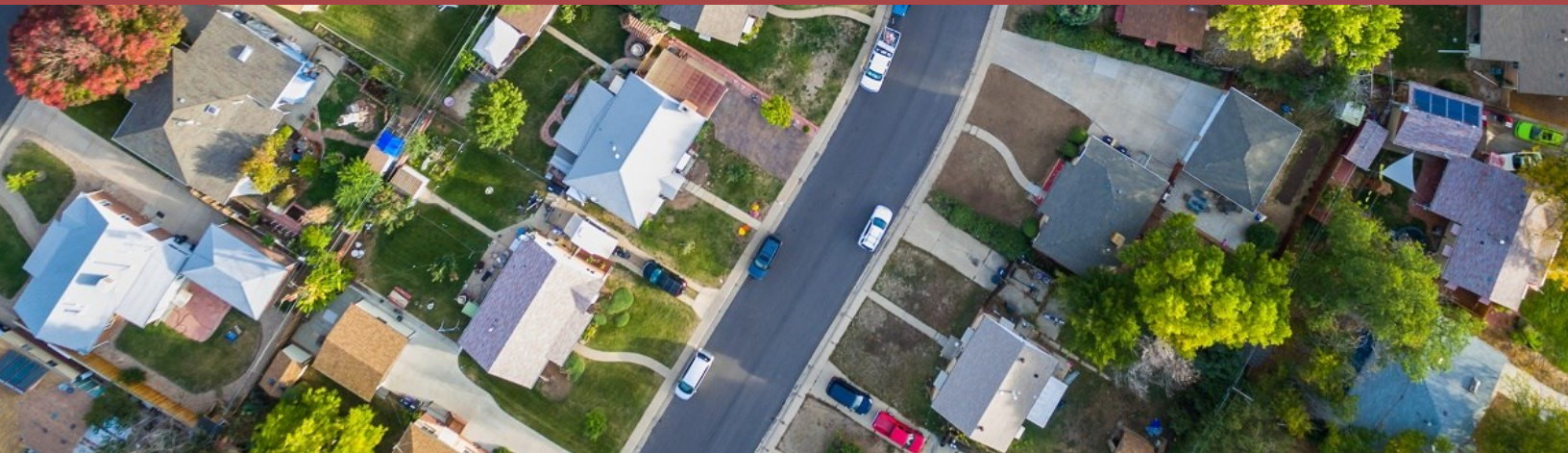





# HOUSING

## Planning for Aging In Place—Key Points on Housing:

### #1 THINK ABOUT WHAT YOU REALLY WANT

Before starting this section, take some time to consider what you really want as you get older since your housing choice will play a big impact on many other elements of your life.

- If you think your current house will keep you happy and fulfilled as you age in terms of proximity to family, friends, services, the outdoors, or any other criteria you have, then consider what needs to be done for you to stay in the house.
- Alternatively, maybe you would prefer a home that requires less maintenance or yard work, is closer to family, is in a location that makes it easier to get around without a car, or is in a different climate.
- On the other hand, maybe you want a different type of housing where friends and neighbors support each other as they age such as a cluster of small homes with friends, a co-housing community, or some other type of shared housing. Options like this exist in many parts of the country but they are not yet common. Pursuing something like this may require you to reach out to others who share your vision to see if you can create the type of housing you want.

### #2 BE PROACTIVE AND IDENTIFY RESOURCES

Identify the challenges that living in and maintaining your home will present over time and think about your capacity to meet those challenges if your physical or financial circumstances change. Deferred home maintenance can quickly snowball, threatening your health and safety, and even the habitability and durability of your home. It's also not uncommon for a surviving spouse to be unaware of monthly, seasonal and annual tasks their partner did to maintain the home and property. Use the seasonal home maintenance checklist provided in the back of this workbook as a guide, and/or create one tailored to your own home. Identify trusted resources for home maintenance and routine chores if you need them down the road. Remember, **planning always reduces cost and increases options.**

### #3 EVALUATE ACCESSIBILITY & FALL HAZARDS - KNOW YOUR LIMITS

Fall prevention is a key factor in remaining in your home for as long as possible. According to the National Center for Injury Prevention and Control, falls are the number one cause of home injury, and studies suggest that a significant proportion of all falls are due to factors around the home that can be easily changed (for example, throw rugs that cause a tripping hazard). It's also important to consider housing accessibility issues before your mobility becomes limited or a traumatic event creates a crisis scenario where returning to your current home is no longer an option.

# HOUSING

## Choice of Residence

Are you comfortable in your current residence?

Yes \_\_\_\_ No \_\_\_\_

Would you like to remain in your current residence for as long as possible?

Yes \_\_\_\_ No \_\_\_\_ Not Sure \_\_\_\_

What makes you want to remain in your current home?

(Check all that apply)

- Location
- Cost
- Size (e.g., # bedrooms, square footage)
- Familiarity
- Local weather
- Accommodations for your physical condition
- Design features
- Energy sources and related costs
- Proximity to stores and services
- Access to local transportation
- Proximity to medical care
- Proximity to family
- Proximity to friends
- Proximity to recreational and/or social opportunities
- Other. *Please explain*

# AGE IN PLACE?



OR



# MAKE A MOVE?

---

---

---

# HOUSING

## Choice of Residence

When thinking about your living situation, are there other things you might prefer?

*Check all that apply.*

- Downsizing to something smaller
- Something less expensive
- Something requiring less maintenance and/or yard work
- One level living (or a master suite on the main level)
- A residence more suitable to my physical condition
- Closer/better access to family
- Closer/better access to friends/opportunities to socialize
- Non-traditional housing options: i.e. cluster, co-housing, or home sharing
- A different climate
- Better access to transportation
- Better access to culture, entertainment or recreation
- A retirement village or other housing restricted to older adults
- A continuum of care community (*offers housing options with increased levels of care from fully independent living to 24-hour nursing home care*)
- Other. *Please explain*

---

---

In assessing the living conditions you desire, what are the things you must have?  
Alternatively, what are some of the things you could live without?

Must Have

Could Live Without

---

---

---

---

---

---

---

---

# HOUSING

## Affordability

Does your monthly mortgage or rent payment **currently** leave you enough money for your other needs?

Yes \_\_\_\_ No \_\_\_\_

Are you reasonably confident that your monthly mortgage or rent payment will continue to be affordable if other expenses in your life were to increase substantially (i.e. medical expenses, supportive services)?

Yes \_\_\_\_ No \_\_\_\_ Not Sure \_\_\_\_

Are your monthly heating/electricity bills affordable, even in the coldest/hottest months?

Yes \_\_\_\_ No \_\_\_\_ Not Sure \_\_\_\_

If your monthly home costs are too expensive (or become too expensive in the future), do you want to consider any of the following?

- Find a home that is less expensive/downsize
- Remain in current home and reduce other expenses
- Explore possible benefits available to you  
(Visit [benefitscheckup.com](http://benefitscheckup.com))
- Property tax deferral plan for seniors (if applicable)
- Find a housemate or home-sharing arrangement
- Have your home/appliances upgraded for energy-efficiency to save on utility bills
- Consider a reverse mortgage (see box below)
- Consider refinancing at a lower interest rate (see box below)

Reverse  
Mortgage?

*be sure to know the...*

positives  
negatives  
pitfalls

### Did You Know?

There are an array of financial mechanisms that could help you reduce your monthly housing costs, but there are also some pitfalls and predatory practices out there! If you are considering a reverse mortgage, a home equity loan, a second mortgage or a refinance of your primary mortgage, AARP has a wealth of information [online](#) that can help you make a more informed decision. You may also want to seek some expert advice from an estate or financial planner. AARP also has great [resources](#) on how to select a financial planner who is also a **fiduciary**, which means that when they give you advice, they are legally obligated to put your financial interests ahead of theirs. Fiduciaries usually work for a flat fee rather than a commission.

# HOUSING

## Safety, Comfort and Accessibility: Entrances

Is there at least one step-free entrance into the home?

Yes \_\_\_\_ No \_\_\_\_ Not Sure \_\_\_\_

Is the main entryway door to your home easy to open?  
*(Consider lever door handles and a bench beside the door to hold packages while you are opening the door )*

Yes \_\_\_\_ No \_\_\_\_ Not Sure \_\_\_\_

Are you able to easily lock and unlock your doors?  
*(consider keypads or remote openers if keys are difficult)*

Yes \_\_\_\_ No \_\_\_\_ Not Sure \_\_\_\_

Are your doorways free from welcome mats, decorations, and any other tripping/slipping hazards?

Yes \_\_\_\_ No \_\_\_\_ Not Sure \_\_\_\_

Does the door have a security peephole or view panel at the correct height for you?

Yes \_\_\_\_ No \_\_\_\_ Not Sure \_\_\_\_

Are there secure handrails on both sides of outdoor steps and indoor stairways at a good height for you?

Yes \_\_\_\_ No \_\_\_\_ N/A (no steps) \_\_\_\_

Are exterior pathways, porches and doorways well lit?  
*(Consider lighting with motion sensors so they will turn on automatically when needed).*

Yes \_\_\_\_ No \_\_\_\_ Not Sure \_\_\_\_

Are the walkways in good condition?  
*(No holes, loose bricks, or uneven areas of pathways.)*

Yes \_\_\_\_ No \_\_\_\_ Not Sure \_\_\_\_

Are the doorways and hallways wide enough to let a wheelchair pass through  
*(32" door & 36" hall)?*

Yes \_\_\_\_ No \_\_\_\_ Not Sure \_\_\_\_

Do doorknobs have lever handles, which are easier to use than rounded knobs?

Yes \_\_\_\_ No \_\_\_\_ Not Sure \_\_\_\_



A zero step entrance makes life easier for daily tasks and serves all ages and abilities

# HOUSING

## Safety, Comfort and Accessibility: General Accessibility & Fall Prevention

Is there a bedroom, full bath, and kitchen on the main living floor?

Yes \_\_\_\_ No \_\_\_\_

Is carpeting on interior steps worn, torn or loose?

Yes \_\_\_\_ No \_\_\_\_ N/A (no steps) \_\_\_\_

### Did You Know?

Among people 65 years and older, falls are the leading cause of injury deaths and the most common cause of nonfatal injuries and hospital admissions. Each year in the United States, nearly one-third of older adults experience a fall. 55 percent of fall injuries among older people occur inside the home and an additional 23 percent happen outside, but nearby. Many of these falls can be prevented by taking steps to eliminate or fix potential hazards in and around the home.



A serious fall injury after age 65 can often precipitate a rapid decline in overall health and reduce a person's ability to live independently.

Are your interior door thresholds flat?

*(consider installing beveled, no step, and no-trip thresholds between rooms. A contrasting color will make transitions more visible for added safety.)*

Yes \_\_\_\_ No \_\_\_\_ Not Sure \_\_\_\_

Are interior steps in good repair?

*(consider refinishing or replacing worn stair treads; consider non-slip adhesive strips to reduce slip hazard on uncarpeted stair treads.)*

Yes \_\_\_\_ No \_\_\_\_ Not Sure \_\_\_\_ N/A (no steps) \_\_\_\_

Can light switches, electrical outlets, and thermostats be easily reached even when seated?

*(light switches and thermostat at 48", outlets at 24" above the floor.)*

Yes \_\_\_\_ No \_\_\_\_ Not Sure \_\_\_\_

Are light switches easy to use? *(consider rocker switches and/or motion detectors)*

Yes \_\_\_\_ No \_\_\_\_ Not Sure \_\_\_\_

Can the windows be opened with minimum effort and from a seated (wheelchair) position if necessary?

Yes \_\_\_\_ No \_\_\_\_ Not Sure \_\_\_\_

# HOUSING

## Safety, Comfort and Accessibility: Steps and Stairs

Can you clearly see the edges of the steps? (*consider painting edge of step with contrasting color so you can see the stairs and landings*)

Yes \_\_\_ No \_\_\_ Not Sure \_\_\_ N/A (no steps) \_\_\_

Are the stairs well lighted?

Yes \_\_\_ No \_\_\_ Not Sure \_\_\_ N/A (no steps) \_\_\_

Are there light switches at both the top and bottom of indoor stairs? (*consider motion sensor lights for stairs*)

Yes \_\_\_ No \_\_\_ Not Sure \_\_\_ N/A (no steps) \_\_\_

Are your stairs free from clutter or other objects that could trip someone?

Yes \_\_\_ No \_\_\_ Not Sure \_\_\_ N/A (no steps) \_\_\_

Would it be feasible to install a stairwell chairlift in your home if it was needed in future?

Yes \_\_\_ No \_\_\_ Not Sure \_\_\_ N/A (no steps) \_\_\_



Contrasting color on steps can help with visibility.



Handrails on both sides. Non-slip strips on edges of stairs.

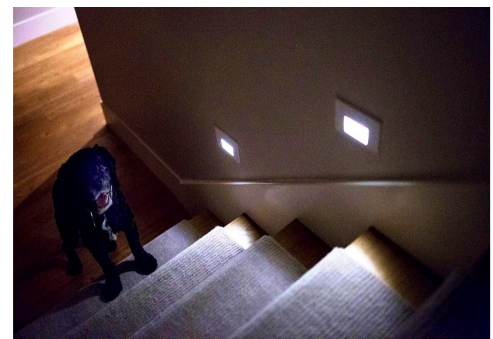

Battery operated motion sensor LED light are easy to install.

### Did You Know?

An **Occupational Therapist** is a professional with specific expertise in helping people across the lifespan do the things they want and need to do. They are trained to observe and understand how an individual functions in her or his space, which is essential in making recommendations that will enhance function and safety in the home environment. This person-centered focus helps ensure that any modifications made to a home will meet both current and future needs. Such unbiased assessments save money in the long run by helping to avoid mistakes in product selections and design solutions.

Occupational therapists are generally paid a flat fee per visit and their services may be covered by health insurance (check with your insurance provider.)

To find a local occupational therapist, ask your physician for a referral or contact a local home health care agency.

# HOUSING

## Safety, Comfort and Accessibility: Bathroom

Is there good lighting in the bathroom? *(consider a night light or glow switch)*

Yes \_\_\_ No \_\_\_

Is the hot water heater set at 120° or lower? *(any hotter wastes energy and is a scald risk)*

Yes \_\_\_ No \_\_\_ Not Sure \_\_\_

Are the sink, bathtub and shower faucets easy to use? *(consider installing lever handles)*

Yes \_\_\_ No \_\_\_ Not Sure \_\_\_

Are there properly installed and located grab bars in the bathtub, shower, and toilet areas?

Yes \_\_\_ No \_\_\_ Not Sure \_\_\_

Is there a handheld or adjustable height showerhead?

*(helpful to those who have trouble bending or who need to bathe from a seated position)*

Yes \_\_\_ No \_\_\_ Not Sure \_\_\_

Does your bathtub or shower have a built-in or removable seat?

Yes \_\_\_ No \_\_\_ Not Sure \_\_\_

Does your bathtub or shower have a walk/roll-in entrance with no threshold?

Yes \_\_\_ No \_\_\_ Not Sure \_\_\_

If you required a wheelchair in the future, would you be able to maneuver in your bathroom?

*(a 5' unobstructed turning radius is ideal)*

Yes \_\_\_ No \_\_\_ Not Sure \_\_\_

Is the bathtub and/or shower floor slip resistant?  
*(consider using non-slip strips on tub or shower floors)*

Yes \_\_\_ No \_\_\_ Not Sure \_\_\_

Do bathmats outside the tub have rubber backing and lie flat?  
*(never use towels or throw rugs on the floor in the bathroom).*

Yes \_\_\_ No \_\_\_ Not Sure \_\_\_

Is the toilet seat at a comfortable height to make it easier to sit down and stand up?

*(consider replacing low toilets with comfort height toilets, or adding a raised toilet seat)*

Yes \_\_\_ No \_\_\_ Not Sure \_\_\_

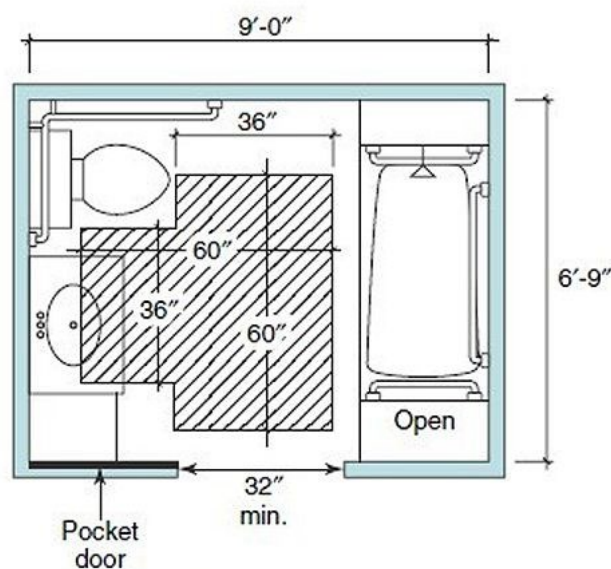

Space for T-Turn



# HOUSING

## Safety, Comfort and Accessibility: Kitchen

Is there good lighting in the kitchen work areas? *(consider LED lighting)*

Yes \_\_\_ No \_\_\_ Not Sure \_\_\_

Are cabinets and cupboards easy to open?

*(see picture at right)*

Yes \_\_\_ No \_\_\_ Not Sure \_\_\_

Are stove controls easily reached from a seated position without exposing your arms, hands or clothing to a flame or electric coils? *(If there are no young children in the house and you are replacing your stove, consider purchasing one with controls at the front.)*

Yes \_\_\_ No \_\_\_ Not Sure \_\_\_

Is a fire extinguisher mounted within easy reach?

Yes \_\_\_ No \_\_\_ Not Sure \_\_\_

Are objects on shelves or in drawers easily accessible? *(move frequently-used items to where you can reach without a step stool. If you do need to use a step stool, make sure it has non-slip steps and a grip handle. Install pull out drawers or lazy susans in lower cabinets.)*

Yes \_\_\_ No \_\_\_ Not Sure \_\_\_

Does the sink have an anti-scald device?

Yes \_\_\_ No \_\_\_ Not Sure \_\_\_

Is there a countertop work area that can be used from a seated (wheelchair) position?

Yes \_\_\_ No \_\_\_ Not Sure \_\_\_

Is the dishwasher raised for easy loading?

Yes \_\_\_ No \_\_\_ Not Sure \_\_\_

Is the refrigerator a side-by-side for easy access?

Yes \_\_\_ No \_\_\_ Not Sure \_\_\_



“C” or “D” shaped handles are easier than knobs for people with limited dexterity.



Contents in pull-out base cabinet drawers are easier to access than standard base cabinets.



Many appliances, countertops, and cabinets are designed to be accessible from a seated position.

# HOUSING

## Safety, Comfort and Accessibility: Living Spaces and Bedrooms

Are all passageways well lit?

Yes \_\_\_ No \_\_\_ Not Sure \_\_\_

Are pathways clear of throw rugs, electrical or telephone cords, and other clutter?

Yes \_\_\_ No \_\_\_ Not Sure \_\_\_

Are carpets free from wrinkles and secured to floor?

Yes \_\_\_ No \_\_\_ Not Sure \_\_\_



1. Non-secured rug is easy to trip over.
2. Exposed cords can easily entangle feet.
3. Objects in walking path and/or clutter create trip hazards.

Are there working smoke and carbon monoxide detectors on each floor of the house and are they near bedrooms? (*CO detectors only needed if combustion appliances present*)

Yes \_\_\_ No \_\_\_ Not Sure \_\_\_

Is the telephone easily accessible from bed?

Yes \_\_\_ No \_\_\_ Not Sure \_\_\_

Are closets well-lit and easy to use? (*consider installing rods and shelves that can be adjusted to different heights to enable access from a wheelchair if needed*)

Yes \_\_\_ No \_\_\_ Not Sure \_\_\_

Is there a lamp on both sides of the bed that is easy to turn off and on?

Yes \_\_\_ No \_\_\_ Not Sure \_\_\_

Are you able to keep your house comfortably warm in winter and cool in summer?

Yes \_\_\_ No \_\_\_ Not Sure \_\_\_

Are your utility bills affordable during the coldest and warmest months?

Yes \_\_\_ No \_\_\_ Not Sure \_\_\_

If you heat with a woodstove, are you able to carry firewood, even in inclement weather?

Yes \_\_\_ No \_\_\_ Not Sure \_\_\_ N/A (no woodstove) \_\_\_

# HOUSING

## Home Safety & Livability: Home and Yard Maintenance

Do you know the maintenance requirements for the appliances and systems in your home?  
(you will find a sample home maintenance checklist in the back of this workbook)

Yes \_\_\_ No \_\_\_ Not Sure \_\_\_ N/A \_\_\_ (covered by rental/condo property manager)

Do you have the physical capability to maintain your home?

Yes \_\_\_ No \_\_\_ Not Sure \_\_\_ N/A \_\_\_ (covered by rental/condo property manager)

Do you have the financial resources to maintain your home (or pay someone to do it )?

Yes \_\_\_ No \_\_\_ Not Sure \_\_\_ N/A \_\_\_ (covered by rental/condo property manager)

Do you have the physical capability to maintain your yard/property?

Yes \_\_\_ No \_\_\_ Not Sure \_\_\_ N/A \_\_\_ (no yard or property to maintain)

Do you have the financial resources to maintain your yard/property (or pay someone to)?

Yes \_\_\_ No \_\_\_ Not Sure \_\_\_ N/A \_\_\_ (no yard or property to maintain)

Do you know who you might contact for specialized home repairs or maintenance?  
(plumbing, electrical, heating/air conditioning, roof/gutters, cleaning/painting)

Yes \_\_\_ No \_\_\_ Not Sure \_\_\_ N/A \_\_\_ (covered by rental/condo property manager)

### Did You Know?

Deferred home maintenance can lead to expensive or even dangerous conditions over time and may diminish your ability to successfully age in place.

For some maintenance tasks, it may make sense to hire a professional. Remember: emergency repairs are almost always more expensive than proper preventative maintenance!

As a part of your aging in place planning, it may also be worth hiring a professional inspector to perform a thorough assessment of your home to identify any structural problems, major system issues, or safety concerns. The American Society of Home Inspectors can be a helpful resource to find a local, certified home inspector:

<http://www.homeinspector.org/HomeInspectors/Find>







## MY PLAN FOR HOUSING

My “Plan A” for housing, i.e. my ideal aging-in-place scenario is:

---

---

---

---

My “Plan B” for housing, if my financial, physical or health circumstances change:

---

---

---

---

Actions I will take to make my “Plan A” probable and my “Plan B” possible:

Keep Doing

Start Doing

---

---

---

---

---

---

---

---

---

---

---

---

---

---

---

---

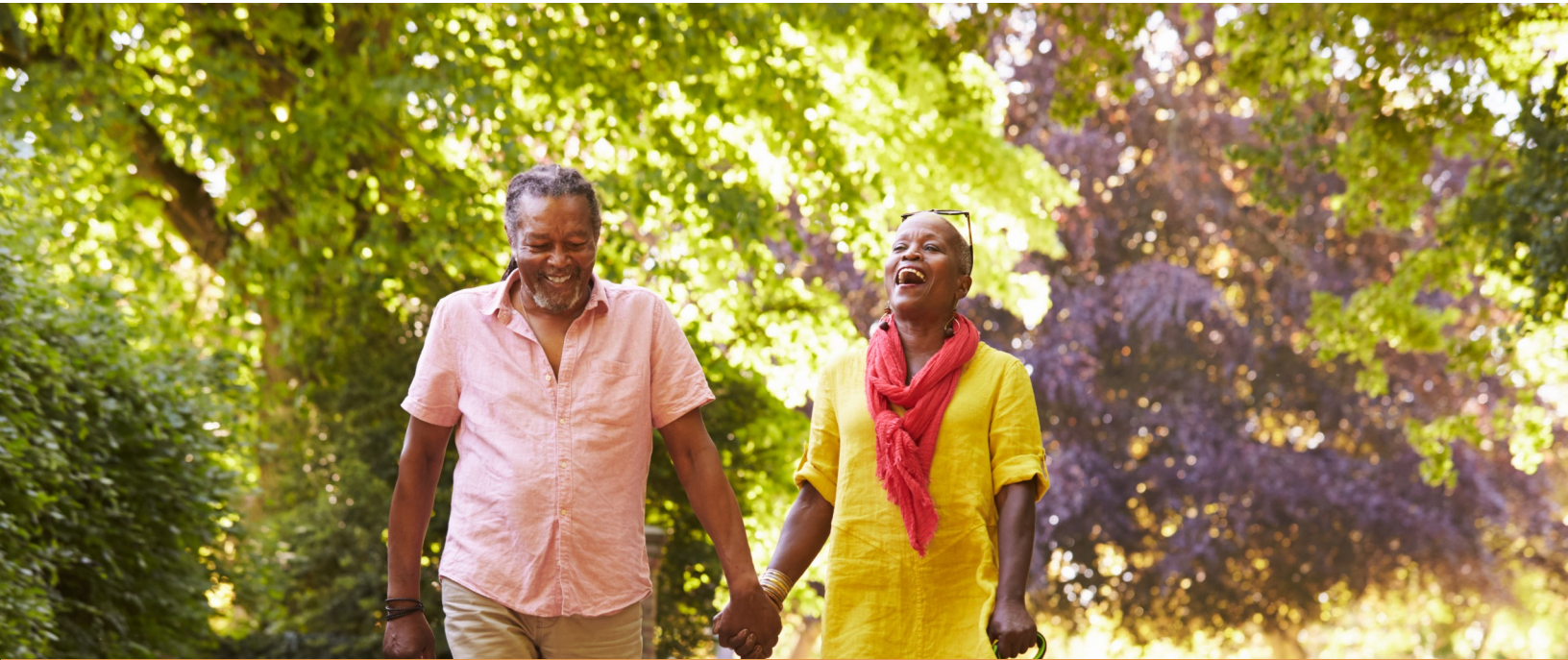

## HEALTH & WELLNESS



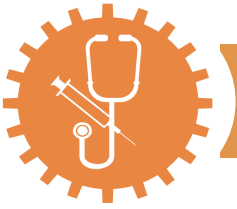

## HEALTH & WELLNESS

### Planning for Aging In Place—Key Points on Health & Wellness

#### #1: MAKE WELLNESS A PRIORITY

The goal of living independently as one ages is highly correlated with one's physical wellness. While health challenges often increase with age, lifestyle choices that maintain or improve health and functional ability can dramatically increase the odds of maintaining independence in your later years.

#### #2: UNDERSTAND RESOURCES AVAILABLE TO YOU

Health insurance costs are usually the largest expense in an older adult's budget. Approximately 80% of older Americans have a chronic health condition and 50% have two or more, making it critically important to have adequate coverage and access to health care later in life. There are many online and community resources available to help you make informed decisions when choosing or re-evaluating your healthcare coverage options.

Because chronic conditions and/or declining functioning can emerge in later life, you also need to plan for the possibility that you may need some supportive in-home assistance or community-based services. Statistics indicate that 70% of people who reach age 65 will need some form of care before the end of their life, which includes both short and long term care. While that statistic can be sobering, it is important to remember that only around 5% of older adults will have to move into a nursing home.

In-home assistance, community-based supportive services and long term care can be an important component in maintaining one's ability to age in place. Finding them poses a challenge at best and can even be overwhelming if searching for them in the midst of an urgent need. Exploring the spectrum of services available and developing a hypothetical support plan (along with the potential cost and eligibility factors) before actually needing them can help alleviate some of the stress in the event they become necessary down the road.

#### #3: MAKE YOUR WISHES KNOWN

The ability to age comfortably and safely in one's home requires making thoughtful and deliberate decisions. This applies as well to healthcare decisions. The importance of having an advance directive can't be stressed enough. If an individual cannot express their wishes regarding treatments and no advance directive is in place, the treatment received might be very different from what they would choose for themselves. Lack of an advance directive can also put family members at odds if there are differences of opinion about treatment, especially decisions involving palliative and hospice care.

# HEALTH & WELLNESS

## Wellness

Do you exercise or engage in moderate to vigorous physical activity\* on a regular basis?  
*\*at least 20 minutes of aerobic or strength-training activity*

- Yes, nearly every day \_\_\_\_\_
- Yes, 3-4 times/week \_\_\_\_\_
- Yes, 1-2 times/week \_\_\_\_\_
- No, I rarely exercise \_\_\_\_\_

Do you eat a healthy, nutritious diet?

Yes \_\_\_ No \_\_\_ Not Sure \_\_\_

Do you think you are at a healthy weight?

Yes \_\_\_ No \_\_\_ Not Sure \_\_\_

Are you a non-smoker?

Yes \_\_\_ No \_\_\_

Do you limit your alcohol intake to 1 drink or less/day?

Yes \_\_\_ No \_\_\_

Do you have a regular medical provider?

Yes \_\_\_ No \_\_\_

Do you visit your medical provider at least annually for a routine checkup and testing?

Yes \_\_\_ No \_\_\_

Do you follow your medical provider's recommendations regarding lifestyle changes, medication, and/or medical treatments?

Yes \_\_\_ No \_\_\_ Not Sure \_\_\_



### Helpful Resources

Recommended physical activity guidelines for older adults:

<https://www.nhs.uk/Livewell/fitness/Pages/physical-activity-guidelines-for-older-adults.aspx>

Better Health While Aging: Practical Information for Aging Health & Family Caregivers:

<https://betterhealthwhileaging.net/>

Recommended list of preventative health screenings for older adults. These are typically covered by Medicare's Annual Wellness Visit:

<http://betterhealthwhileaging.net/wp-content/uploads/pdfs/preventivecareaging.pdf>



# HEALTH & WELLNESS

## Did You Know?

### MEDICARE

is the United States federal government health insurance program for Americans aged 65 and older. These benefits, which people pay into over their working lives, are intended to provide affordable healthcare to older Americans at a time in their lives when they are facing higher healthcare costs and declining incomes. The different parts of Medicare offer different coverage. It is important to familiarize yourself with each during open enrollment periods so your coverage is more likely to meet your anticipated healthcare needs and minimize gaps in coverage or unaffordable out-of-pocket expenses.

#### MEDICARE PART



COVERS HOSPITAL-RELATED SERVICES AND EMERGENCY CARE



#### MEDICARE PART



COVERS DOCTOR'S OFFICE VISITS



#### MEDICARE PART



COVERS BOTH PART A AND PART B WITH ADDITIONAL COVERAGE



#### MEDICARE PART



COVERS PRESCRIPTION DRUGS



### MEDICAID

is a need-based state assistance program for low-income people of every age that covers a broad range of assistance. People with Medicare *may* also qualify for Medicaid based on income, assets or very high medical bills. There are many different eligibility groups in the Medicaid program and each one has its own set of requirements. Coverage varies from state to state. Some people with Medicare may qualify for partial Medicaid coverage that will act like a Medicare supplemental policy and cover Medicare co-pays, etc.

Due to the complexity of Medicaid eligibility and coverage rules it is important that you understand as much as possible about them before applying. Local Departments of Social Services usually administer the Medicaid program to determine eligibility. Websites that may be helpful include: [Medicaid.gov](https://www.Medicaid.gov) and [benefitscheckup.org](https://www.benefitscheckup.org).

# HEALTH & WELLNESS

## Healthcare Coverage (Medicare)

For many older adults, healthcare can be one of the largest expenses, and unfortunately, one of the hardest to predict. Investigating your best options for covering your healthcare needs is one of the most critical elements of successfully planning for aging in place.

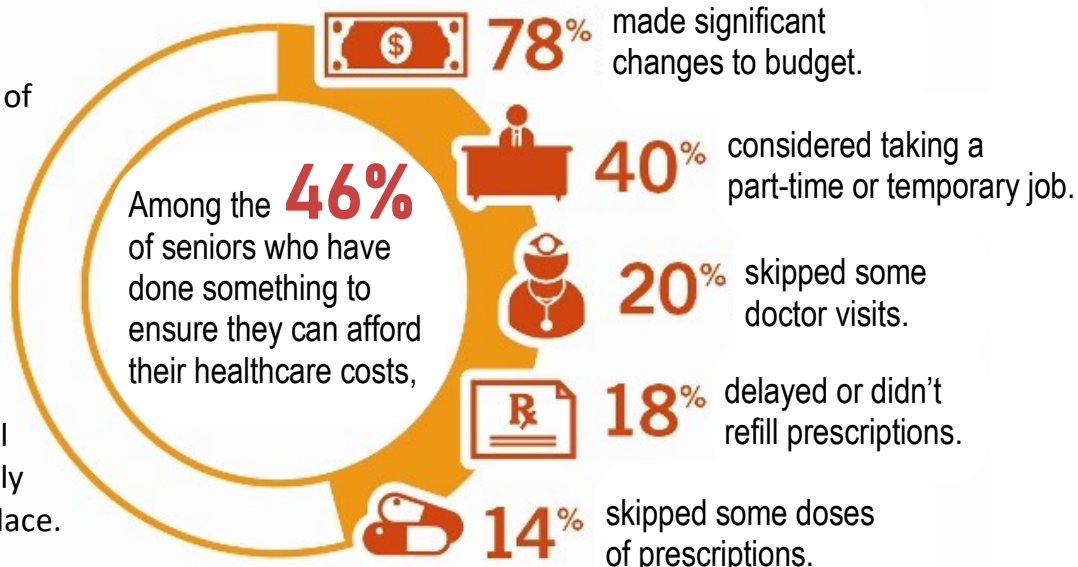

Do you feel you have a sufficient understanding of the benefits provided by Medicare?

Yes \_\_\_ No \_\_\_ Not Sure \_\_\_

Are you eligible for Medicare?

Yes \_\_\_ No \_\_\_ Not Sure \_\_\_

If you answered “**yes**”: Have you enrolled? Yes \_\_\_ No \_\_\_ (If you answered “**no**”, please skip to the “Private Healthcare Plans” section on the following page)

If you answered, “**not sure**” check out this website: <https://www.mymedicarematters.org/enrollment/am-i-eligible/> or you can contact your local Area Agency on Aging for more information.

If you are enrolled in Medicare are your benefits enough to cover your anticipated medical costs?

Yes \_\_\_ No \_\_\_ Not Sure \_\_\_

If you answered “**no**” or “**not sure**”,

Have you used [Medicare.gov](https://www.medicare.gov) to review and compare Medicare plans available to you? (It is recommended that users compare available Medicare Part D plans annually during open enrollment, as plans often change year to year.)

Yes \_\_\_ No \_\_\_

Have you used [benefitscheckup.org](https://www.benefitscheckup.org) to determine if you might be eligible for additional medical benefits or programs?

Yes \_\_\_ No \_\_\_

# HEALTH & WELLNESS

## Healthcare Coverage (Private)

(NOTE: If you are eligible for Medicare, please skip this section)

If you are not eligible for Medicare, do you have a private health care plan?

Yes \_\_\_ No \_\_\_

If you answered “no”:

a. Can you afford a private plan?

Yes \_\_\_ No \_\_\_ Not Sure \_\_\_

b. Have you used healthcare.gov to compare available plans? (link at right)

Yes \_\_\_ No \_\_\_

If you answered “yes”:

a. Are your benefits sufficient to cover your anticipated medical costs?

Yes \_\_\_ No \_\_\_ Not Sure \_\_\_

If you have a high-deductible health plan, do you utilize the benefits of a [Health Savings Account](#)? (or search for Health Savings Account on [AARP.org](#))

Yes \_\_\_ No \_\_\_ n/a \_\_\_

If you are employed, does your employer offer [Flexible Spending Accounts](#)? (or search for Flexible Spending Account on [AARP.org](#))

Yes \_\_\_ No \_\_\_ n/a \_\_\_

### Did You Know?

Older adults between the ages of 50 and 64 often experience rising out-of-pocket healthcare expenses. A recent AARP Public Policy Institute study found that one in three adults in this pre-Medicare eligibility group is spending at least 10 percent of their after-tax income on healthcare.

If you retire before 65 without health coverage, or are still working but not eligible for health insurance through your employer, you may want to explore your options via the Healthcare.gov Health Insurance Marketplace. There you can find out if you qualify for a private plan with premium tax credits and lower out-of-pocket costs depending on your income and household size.

<https://www.healthcare.gov/retirees/>

### Did You Know?

In 2017, the average monthly healthcare cost for a healthy person with Medicare and supplemental insurances was estimated at \$628 per month (source: Motley Fool). This includes the cost of premiums for Medicare Parts B and D and a Medigap Supplement along with deductibles and co-pays. These costs can vary a great deal for individuals based on health status, use of health care services and medications needed. Keep in mind that premiums and deductibles can change annually.

The State Health Insurance Assistance Programs (SHIPS) provide local in-depth, and objective insurance counseling and assistance to Medicare-eligible individuals and caregivers. To find your local program go to [www.shiptacenter.org](http://www.shiptacenter.org) or call 1-877-839-2675

# HEALTH & WELLNESS

## Daily Living/In-Home and Community-Based Care

Are any of these daily activities challenging for you to perform without assistance?

Check all that you have trouble performing on your own:

- Bathing and showering
- Personal hygiene and grooming  
(including washing hair)
- Toileting hygiene
- Dressing
- Eating
- Managing personal medical devices  
(hearing aid, oxygen, etc.)
- Transferring (getting in and out of bed  
and chairs and on and off toilet)
- Functional mobility (getting around  
your home and community)

### Did You Know?

Caregivers can be hired through local licensed agencies, registries maintained by hospitals, or other community-based organizations to assist with activities of daily living such as bathing, grooming, eating, etc.

Medicare rarely pays for personal care services. Typically they will only be covered when skilled services from a Licensed Nurse or Therapist are needed and ordered by a physician.

For information on long-term care services, please see page 29.

If you currently need help (or anticipate that you could need help in the future) with any of the items listed above, do you have a family member or friend who can support you with these activities on a short-term basis?

Yes \_\_\_ No \_\_\_ Not Sure \_\_\_

Do you have someone who could support you with these activities on a longer-term basis?

Yes \_\_\_ No \_\_\_ Not Sure \_\_\_

If you answered “**yes**”, have you had a discussion to confirm what they are willing and able to do for you?

Yes \_\_\_ No \_\_\_ Not Sure \_\_\_

If you answered “**no**” or “**not sure**” to any of the questions above, do you have the financial resources to hire a caregiver to assist you with your daily activities?

Yes \_\_\_ No \_\_\_ Not Sure \_\_\_



# HEALTH & WELLNESS

## Daily Living/In-Home and Community-Based Care

Do you have a chronic medical condition that requires daily monitoring and/or treatment?

Yes \_\_\_ No \_\_\_ Not Sure \_\_\_

If you answered “**yes**”:

Are you able to manage your medical condition on a daily basis?  
*(using medical equipment, monitoring blood glucose levels, etc.)*

Yes \_\_\_ No \_\_\_ Not Sure \_\_\_

If you answered “**no**”:

Do you have a caregiver (family member, friend, volunteer, or paid helper) who can assist you with managing your medical condition?

Yes \_\_\_ No \_\_\_ Not Sure \_\_\_

Have you consulted with your doctor to see if your health care system has a care manager who can advise you on how to better manage your condition?

Yes \_\_\_ No \_\_\_ Not Sure \_\_\_



Managing medications can be a challenge, especially with multiple prescriptions or when memory impairment is involved. Are you able to manage your daily medication(s) without assistance?

Yes \_\_\_ No \_\_\_ Not Sure \_\_\_

If you answered “**no**” or “**not sure**”:

Have you researched and considered any medication management systems?

Yes \_\_\_ No \_\_\_

Have you investigated whether a family member, friend or in-home care provider could assist you in ensuring your medications are taken as prescribed?

Yes \_\_\_ No \_\_\_

# HEALTH & WELLNESS

## Daily Living/In-Home and Community-Based Care

Area Agencies on Aging offer no-cost or low-cost programs, services, and information to older adults, adults with disabilities, and caregivers; and are dedicated to helping people with a host of issues related to aging.

### Common Area Agency on Aging Programs and Services (may vary by locality)

- Care Coordination Services
- Congregate Meals
- Elder Abuse Prevention
- Home Delivered Meals
- Homemaker Services
- General Info and Assistance
- Legal Services
- Medical Transportation
- Ombudsman Program
- Respite Care/Caregiver Support
- Volunteer Opportunities
- Insurance Counseling Program

Have you looked into whether your community has an Area Agency on Aging?

Yes \_\_\_ No \_\_\_

#### Did You Know?

The Eldercare Locator is a free nationwide service that connects older Americans and their caregivers with local support resources such as Area Agencies on Aging. Go to <https://eldercare.acl.gov> or call 1-800-677-1116 to find one near you.

## Personal Health Records

A personal health record, or PHR, is an electronic means for patients to maintain and manage their own health information in a private, secure, and confidential manner. They typically include information such as lists of diagnoses, medications, allergies, surgeries, and immunization histories.

Do you have a personal health record (PHR)? Or do you keep a current list of your physicians, health conditions, and medications (including dosages)?

Yes \_\_\_ No \_\_\_ Not Sure \_\_\_

If you answered “no” or “not sure”:

Check with your insurance company or medical provider to see if they provide PHRs. If not, there are commercially available ones online. Many PHR systems can be automatically accessed by medical personnel; others will provide a printed card with a password.

Regardless of how you record and maintain your personal health records, it is vital that trusted members of your caregiving and healthcare team are able to access them in an emergency situation.

# HEALTH & WELLNESS

## Long Term Care Needs and Coverage

If you should need it over an extended period of time, do you have a plan for how you will cover the cost of long-term care services that will meet your health and personal care needs (help with such things as bathing, dressing, eating, getting in and out of bed or a chair, moving around and using the bathroom)?

Yes \_\_\_ No \_\_\_ Not Sure \_\_\_

If you answered “no” or “not sure”:

Have you considered whether you can afford to pay out of pocket for these services?

Yes \_\_\_ No \_\_\_ *(It is important that you research the cost of long-term care services and factor in inflation)*

Have you considered purchasing a private long-term care policy or explored other private pay coverage for long-term care services?

Yes \_\_\_ No \_\_\_ *(Deciding whether or not to get long-term care insurance depends on your situation and preferences. There is no “one-size-fits-all” policy. Research, consider different options, and talk with a professional before finalizing any decision.)*

Have you explored eligibility for Long-Term Care Medicaid Coverage?

Yes \_\_\_ No \_\_\_ *(You might be able to get help through Medicaid, the federal and state health insurance program. In addition to income and asset requirements there are functional requirements regarding activities of daily living [such as bathing, dressing, transferring, toileting, eating and/or cognitive functioning.]*

Have you explored using your home’s equity for a reverse mortgage to help pay for long-term care services?

Yes \_\_\_ No \_\_\_ *(A reverse mortgage could be helpful to cover long-term care costs. However, not all reverse mortgages are the same and their long-term consequences should be carefully considered and understood before signing.)*

### Did You Know?

Medicare will not cover long-term care services; it only covers short nursing home rehab stays or limited amounts of home health care when you require skilled nursing or rehab. It does not cover custodial care, which includes supervision and help with day-to-day tasks.

Purchased Long-Term Care Insurance policies may cover in-home services.

Policies vary regarding eligibility requirements, services covered, co-pays, and premiums for the covered services.

Be sure you thoroughly understand any long-term care insurance policy before purchasing it. For more information please visit this website:

[longtermcare.acl.gov](http://longtermcare.acl.gov)

or contact your local

State Health Insurance Program:

[shiptacenter.org](http://shiptacenter.org)

# HEALTH & WELLNESS

## Palliative and Hospice Care

The topic of palliative and hospice care can be a difficult one for individuals and their loved ones. It is far better to be proactive with planning so you are not forced to cobble together imperfect or undesirable solutions in the midst of a crisis.

Have you thought about how you would want to approach your final months and days in terms of desired setting, treatment decisions, physical comfort, spiritual/emotional needs, and support options for your family and caregivers?

Yes \_\_\_ No \_\_\_ Not Sure \_\_\_

Have you discussed these wishes with your family members and loved ones?

Yes \_\_\_ No \_\_\_ Not Sure \_\_\_

Are you familiar with the differences between palliative care and hospice care?

Yes \_\_\_ No \_\_\_ Not Sure \_\_\_

Would you know where to turn to get your questions answered about palliative care and/or hospice care?

Yes \_\_\_ No \_\_\_ Not Sure \_\_\_

### Did You Know?

Palliative care is a specialized approach to easing suffering for people with serious illness. It's about relieving pain, reducing symptoms and easing stress. It's also about honoring people's personal wishes and values. This may include a need for medications, counseling, faith-based support and better communication with health care providers about treatment options.

Research suggests that palliative care may even prolong a person's life. It has been shown to ease symptoms such as fatigue, shortness of breath and depression. Further, it can reduce spending on avoidable hospital costs.

And it's important to keep in mind that palliative care is not limited to end-of-life issues. It does not preclude treatment to cure the underlying problem or prolong life. Your local Area Agency on Aging should be able to point you toward some resources on palliative/hospice care. AARP has also published many useful resources on the topic.

Visit: <https://www.aarp.org/> and search the keywords "palliative" and/or "hospice" to learn more.

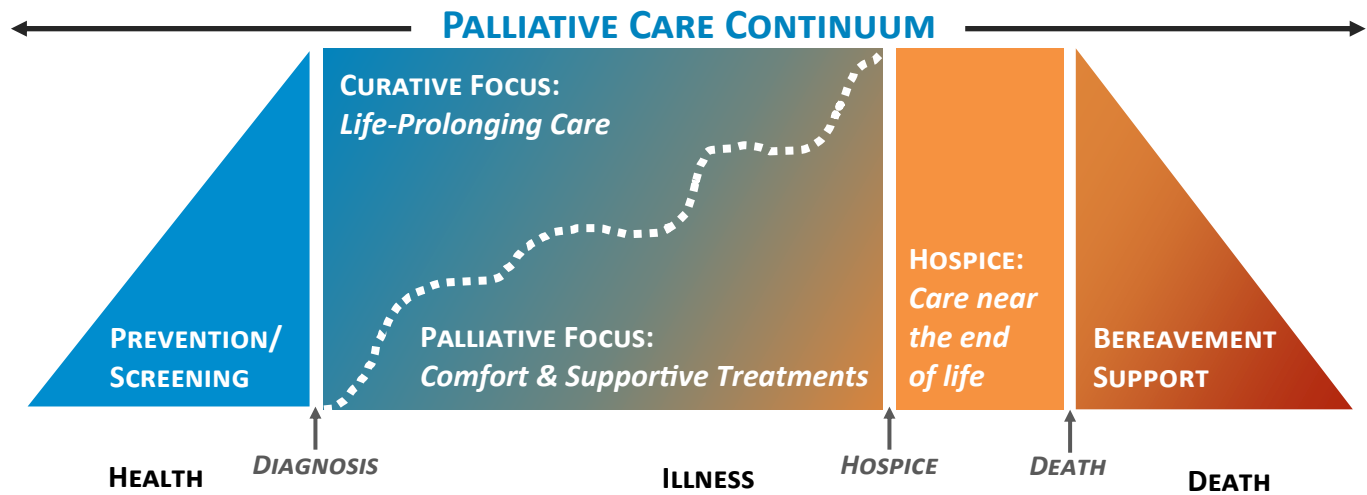



# HEALTH & WELLNESS

## Advance Directives

In the event that you are no longer able to make decisions about your health care it is important to have plans in place to ensure that your wishes are considered. If you are just getting started with advance directives, or have questions about how they work, the following resources may be helpful to you: <https://www.nhdd.org/public-resources> and <https://dementia-directive.org/>

Listed below are types of advance directives (a legal document by which a person makes provision for health care decisions in the event that he/she becomes unable to make those decisions for themselves.) While it very important to create these documents, it is equally critical to share them with family and trusted advocates and make sure they are accessible when the need arises, otherwise your wishes may not be honored.

*Check all the advance directive documents that you have in place and have made accessible to the appropriate person(s):*

- Advance Directive** (A written statement detailing your desires regarding medical treatment if you are no longer able to express informed consent.)
- Durable Power of Attorney for Health Care** (A document that lets you name someone else to make decisions about your health care if you are unable to make decisions for yourself. It gives that person, called an agent, instructions about the kinds of medical treatment you want.) \* may be combined with Advance Directive
- Do Not Resuscitate Order** (A DNR is a request not to have cardiopulmonary resuscitation (CPR) if your heart stops or if you stop breathing.) Important: Be sure that you have a durable DNR so that it is transferable across institutions.

### Did You Know?

82%

OF PEOPLE SAY IT'S IMPORTANT TO  
PUT THEIR WISHES IN WRITING

*yet only...*

23%

HAVE DONE IT.



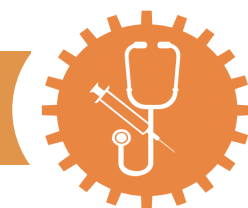

## MY PLAN FOR HEALTH & WELLNESS

My “Plan A” for health & wellness, i.e. my ideal aging in place scenario is:

---

---

---

---

My “Plan B” for health & wellness, if my financial, physical, or health circumstances change:

---

---

---

---

Actions I will take to make my “Plan A” probable and my “Plan B” possible:

Keep Doing

---

---

---

---

---

---

---

---

---

Start Doing

---

---

---

---

---

---

---

---

---



## TRANSPORTATION





# TRANSPORTATION

## Planning for Aging In Place—Key Points on Transportation:

### #1: SAFE DRIVING IS ABOUT ABILITIES, NOT AGE

Although physical changes can occur naturally in our brains and bodies as we age, there is no set age after which a person should stop driving. Statistically, injuries and fatalities from car crashes are much more common among drivers aged 16-24 than among drivers over the age of 70. However, the data show a substantial rise in crash incidence after age 70 (compared to other adult drivers), when miles driven are considered. The factors that can affect an older person's ability to drive safely are: changes to vision, hearing, reaction time, physical ability, cognitive processing, general health, and the impact of certain medications. Arguably, an impaired driver puts his or her self and other people at serious risk of injury or even death, and this circumstance should never be dismissed as harmless or ignored. Because changes can creep up slowly, it's important for older drivers to look for early warning signs and commit to periodically assessing the physical and cognitive abilities needed for safe driving. Assessment resources are readily available, including a self-evaluation developed through the MIT AgeLab, and available online through AARP.

### #2: FOCUS ON GETTING YOU WHERE YOU NEED TO GO

Most people equate driving with independence and that's not entirely unreasonable. American towns and cities are designed and built for individual car ownership. Studies show that older adults who have convenient and affordable transportation options available to get where they need to go (with a car or without) spend more time engaged in their communities, and score higher on several measures of successful aging.

One thing is certain: the nature of transportation is changing. Many communities are working hard to expand public transportation options and make the transportation network safer and more convenient for pedestrians and cyclists. Ride-hailing services like Uber and Lyft have transformed and are largely replacing taxi services. Autonomous or driverless cars are being tested and may become commonplace in the future. Together, these changes have the potential to transform transportation options for drivers and non-drivers alike. That said, the range of transportation choices available will vary based on where you choose to live. Towns with larger populations are likely to have more options. If you live in a rural area, you may have fewer choices, and be more reliant on rides from family, friends, and community organizations in the event you are no longer able to drive or are uncomfortable doing so under certain conditions.

### #3: DEVELOP A PLAN

Like young drivers, older drivers deeply value the independence and mobility that driving provides. Making the decision to stop or limit your driving can be an emotional and life-altering decision. Therefore, it's important to develop an a concrete plan for how you will get where you need to go well before you have to limit or stop driving.

# TRANSPORTATION

## Transportation: Abilities Not Age

What is your current primary means of transportation?

- Driving myself
- Spouse/Partner primarily drives
- Friends and family
- Volunteer ride services
- Walking or biking
- Public transportation
- Taxi or ridesharing services (Uber/Lyft)

If you drive your car, do you feel comfortable...

- a. Driving at night?  
Yes \_\_\_ No \_\_\_ Not Sure \_\_\_
- b. Driving in heavy traffic?  
Yes \_\_\_ No \_\_\_ Not Sure \_\_\_
- c. Driving on a highway?  
Yes \_\_\_ No \_\_\_ Not Sure \_\_\_
- d. Driving to unfamiliar places?  
Yes \_\_\_ No \_\_\_ Not Sure \_\_\_

Have you noticed that you limit or modify your driving in any of the circumstances or settings listed above?

Yes \_\_\_ No \_\_\_ Not Sure \_\_\_

Have you asked the people in your family or others close to you if they agree you are a safe driver?

Yes \_\_\_ No \_\_\_ Not Sure \_\_\_

If you answered “no” or “not sure”, are you willing to take an assessment of your vision, reaction time, and other functions necessary for safe driving?

Yes \_\_\_ No \_\_\_ Not Sure \_\_\_

If you answered “yes”, have you, your family, or your doctor discussed the factors that *could* impair your ability to drive safely in the future?

Yes \_\_\_ No \_\_\_ Not Sure \_\_\_

### Did You Know?

If you are uncertain if you or a family member should continue driving, the following resource may be of help:

[https://s0.hfdstatic.com/sites/the\\_hartford/files/your-road-ahead-2012.pdf](https://s0.hfdstatic.com/sites/the_hartford/files/your-road-ahead-2012.pdf)

### Warning Signs to Look For:

- Delayed response to unexpected situations
- Becoming easily distracted while driving
- Decrease in confidence while driving
- Having difficulty moving into or maintaining the correct lane of traffic
- Hitting curbs when making right turns or backing up
- Getting scrapes or dents on car, garage or mailbox
- Having frequent “close calls”
- Driving too fast or too slow for road conditions

# TRANSPORTATION

## Transportation: Getting Where You Need To Go

Are there activities or trips that are challenging for you to get to due to lack of transportation? (Select all that apply)

- |   |  |
|---|--|
| <input type="checkbox"/> Attending clubs or social events | <input type="checkbox"/> Buying groceries/shopping   |
| <input type="checkbox"/> Visiting family/friends          | <input type="checkbox"/> Outdoor recreation/exercise |
| <input type="checkbox"/> Attending religious services     | <input type="checkbox"/> Medical/dental appointments |
| <input type="checkbox"/> Volunteering                     | <input type="checkbox"/> Other: _____                |

Look at the activities above and think about your average month.

If you had no transportation obstacles, about how many trips would you typically take over a 30 day period? \_\_\_\_\_

If you are (or become) uncomfortable or unable to drive yourself, what other transportation options would be accessible, affordable, and convenient for you?

- |  |   |
|--|---|
| <input type="checkbox"/> Spouse/Partner able to drive me | <input type="checkbox"/> Taxi or ridesharing services (Uber/Lyft) |
| <input type="checkbox"/> Walking or biking               | <input type="checkbox"/> Friends and family                       |
| <input type="checkbox"/> Public transportation           | <input type="checkbox"/> Volunteer ride services                  |

### Did You Know?

Depending on where you live, you may have access to a wider range of affordable and/or convenient transportation options. In many cases, it may be possible to get rides from family, friends, neighbors or volunteers.

It's also worth exploring the potential cost of having to pay for transportation if you need it, keeping in mind that prices can vary a great deal for distance, time of day, weather conditions, and other demand factors.

In recent years, ride-hailing services like Uber and Lyft have largely replaced taxi services.

These can be very helpful for people who are no longer able to drive or comfortable doing so. Ride-hailing services typically require you to download an app onto a smart phone and create an account. If you don't have a smart phone, but still want to be able to use a ride-hailing service, there are specialized companies such as [GoGoGrandparent](#) that enable you to access a ride-hailing service without having to own a smart phone. With this type of service, you can also select a designated family member or friend who is kept informed of when you request a ride and where you are going.

# TRANSPORTATION

## Transportation: Getting Where You Need To Go

If you do not have access to the transportation that you need, would you consider moving to an area where it is more readily available?

Yes \_\_\_ No \_\_\_ Not Sure \_\_\_

Are you comfortable using public transit?

Yes \_\_\_ No \_\_\_ Not Sure \_\_\_

Are you comfortable arranging the type of transportation that you need, such as local paratransit or a ride-hailing service, or do you need assistance from someone else?

Yes \_\_\_ No \_\_\_ Not Sure \_\_\_

### Did You Know?

If you have seen buses driving around your community then you have a local transit service. Contact your local government to find out the routes and fares to see if the transit system goes to places you frequent and could serve as your means of transportation.

Every public transit system also offers a para-transit service to assist those who are unable get to designated bus stops. With para-transit, a smaller bus comes to your home to pick you up and take you where you need to go. Again, contact your local government to get information on how you can access this service.

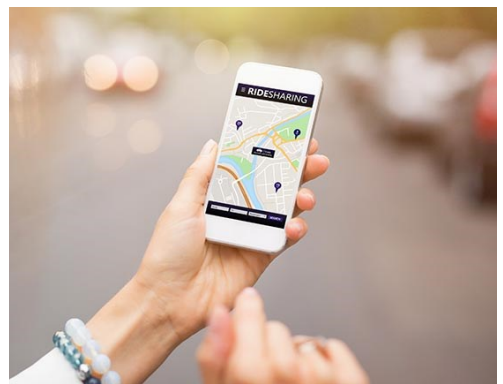



# TRANSPORTATION

## Transportation: Develop a Plan

The aging process affects people differently, and on different timetables. People can experience minimal, moderate, or significant declines in vision, hearing, reaction time, and cognitive processing. It all depends on the person and their particular physiology. It's not a personal failing or a sign of weakness, it's just reality. It's also important to keep in mind that it's not all or nothing. You may not need to limit your driving at all if you are only experiencing a minimal decline in these senses or functions, although a tad more vigilance couldn't hurt. A moderate decline in your senses or functioning can often be accommodated by limiting driving to certain circumstances and settings (daylight hours, familiar routes, good weather), adjusting medications, or by utilizing assistive technologies (hearing aids, glare reduction glasses, backup/side cameras, collision avoidance systems).

Unfortunately, a significant decline in one or more of your senses or functioning probably means it is unsafe for you to drive under any circumstances.

Preparing for potential changes in one's ability to drive is important. Four steps you can take

- Commit to having an annual evaluation with your medical provider to test for a significant decline in any of the senses and functions needed for safe driving: vision, hearing, reaction time, cognitive processing.
- Have candid conversations with your family about how you plan to:
  - modify your driving if you are experiencing minor but manageable declines in any of the key senses or functions.
  - stop driving altogether if an evaluation reveals a significant decline in one or more senses or functions that cannot be managed by a medication adjustment or assistive technology.
- Investigate and become familiar with alternative options that get you where you need to go (that are accessible, affordable, and convenient). Think about your day-to-day trips as well as your travel needs outside the NRV. Take them for a "test drive" well before you need them!
- Set aside some money to pay for your routine transportation needs in the event you need to significantly limit your driving or stop altogether.





# TRANSPORTATION



## MY PLAN FOR TRANSPORTATION

My “Plan A” for transportation, i.e. my ideal aging in place scenario is:

---

---

---

---

My “Plan B” for transportation, if my financial, physical or health circumstances change:

---

---

---

---

Actions I will take to make my “Plan A” probable and my “Plan B” possible:

Keep Doing

---

---

---

---

---

---

---

---

Start Doing

---

---

---

---

---

---

---

---



## PERSONAL FINANCE



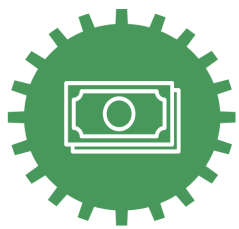

# PERSONAL FINANCE

## Planning for Aging In Place—Key Points on Personal Finance:

### #1: DEVELOP A CLEAR PICTURE OF YOUR POST-RETIREMENT FINANCES

How do you want to live in retirement? What kind of lifestyle do you want to have? Having a financial plan is key because it identifies your sources of income and expenses and will help you establish a realistic retirement budget based on your personal goals. The first step is to take a look at the big picture, i.e. your net worth (what you own minus what you owe). The second step is to create a monthly budget based on what you think your expenses are/will be in retirement including a bit of cushion for emergencies or unexpected events. Even if you are already retired, having a plan will help you keep track of expenses and will enable you to adjust your goals if unforeseen costs arise. Remember, retirement will be more enjoyable and secure if your income is structured to fit your lifestyle choices and if you have developed a retirement plan to protect the assets you have worked hard to acquire.

### #2: GET ADVICE

No doubt about it, retirement is a big life change. And to many, it can feel overwhelming to try to make sense of the complex financial decisions ahead. *Should I take my pension as a lump sum or as an annuity? When should I file for Social Security? Should I pay off my mortgage or focus on other debt? Is a reverse mortgage a good idea? Will I be able to afford health insurance during the bridge years between when I retire and Medicare eligibility? After I retire, do I still need life or long-term disability insurance?* These are all big decisions. In reality, few people possess the expertise, the time, or the desire to actively plan for and manage these aspects of their financial lives.

Consider reaching out to a financial advisor who can help answer your important questions. They have the expertise to assess the big picture of your financial situation and help you look forward so you can better see how well-prepared you are for retirement under different potential scenarios. A financial advisor can also offer guidance on advantageous ways to save and spend **before and after** you retire. Depending on your needs, you may also want to seek additional guidance from a tax advisor or an attorney with estate planning expertise.

### #3: CREATE AND SHARE KEY DOCUMENTS

Peace of mind is key for you as you age, as it is for your loved ones. They need to know where you store important documents when you are no longer able to speak for yourself. Ensuring they have access to these will go a long way in helping them honor your wishes. Questions you should be asking:

- Do I have the appropriate documentation with regard to my financial records?
- Are these documents up to date?
- Do any of them need to be revised to reflect my current life situation or preferences?
- Do key people know where these documents are and how to access them?

# PERSONAL FINANCE

## Understanding Your Income & Assets

Do you feel confident that you have/will have enough money (savings, income, assets) to support yourself through the remainder of your life?

Yes \_\_\_ No \_\_\_ Not Sure \_\_\_

If you answered “no” or “not sure”:

Have you thought about strategies to either increase your retirement income or reduce your expenses? Some examples include:

- |                          |   |                |
|--------------------------|---|----------------|
| <input type="checkbox"/> | Establishing a savings/retirement account | Yes ___ No ___ |
| <input type="checkbox"/> | Delaying retirement                       | Yes ___ No ___ |
| <input type="checkbox"/> | Phased retirement with part-time work     | Yes ___ No ___ |
| <input type="checkbox"/> | Modifying your savings withdrawal rate    | Yes ___ No ___ |
| <input type="checkbox"/> | Converting other assets to savings        | Yes ___ No ___ |
| <input type="checkbox"/> | Converting home equity to savings         | Yes ___ No ___ |
| <input type="checkbox"/> | Eliminating unnecessary expenses          | Yes ___ No ___ |
| <input type="checkbox"/> | Revising insurance needs                  | Yes ___ No ___ |

Are you currently collecting Social Security benefits?

Yes \_\_\_ No \_\_\_

If you answered “no”:

Have you decided when you will collect your Social Security benefits?

*(The earlier in life you start collecting benefits, the lower your monthly check will be.)*

Yes \_\_\_ No \_\_\_ Not Sure \_\_\_

Do you have savings, pensions or other funds set aside?

Yes \_\_\_ No \_\_\_ Not Sure \_\_\_

If you answered “yes”:

Please select all the funds below that you have:

- |                          |              |                          |                |
|--------------------------|--------------|--------------------------|----------------|
| <input type="checkbox"/> | 401K Account | <input type="checkbox"/> | Investments    |
| <input type="checkbox"/> | IRA account  | <input type="checkbox"/> | Annuities      |
| <input type="checkbox"/> | Bank savings | <input type="checkbox"/> | Trust Accounts |

Do you know where these funds are located and how to access them?

Yes \_\_\_ No \_\_\_ Not Sure \_\_\_

### Did You Know?

You can learn more about finding a financial advisor and the questions you should ask about your advisor’s approach, fees, and commission, at: [www.economiccheckup.org/financial-advisor-and-counseling](http://www.economiccheckup.org/financial-advisor-and-counseling)

# PERSONAL FINANCE

## Understanding Your Expenses

Have you calculated how much money you expect to need in retirement?

Yes \_\_\_ No \_\_\_ Not Sure \_\_\_

Have you estimated your taxes in advance of retirement? *(For example, which sources of income will you pay taxes on and what will be left? The goal here is to have a good sense of the actual amount of money that will be available to you each year. Consider getting a tax advisor before retirement, as there can be a lot of issues to deal with that you've never encountered before .)*

Yes \_\_\_ No \_\_\_ Not Sure \_\_\_

Do you expect to be free of debt in retirement?

Yes \_\_\_ No \_\_\_ Not Sure \_\_\_

Do you currently have a detailed budget for your income and expenses?

Yes \_\_\_ No \_\_\_ Not Sure \_\_\_

Do you have a plan to cover anticipated expenses during retirement?

Yes \_\_\_ No \_\_\_ Not Sure \_\_\_

Do you have a plan to cover unexpected or emergency expenses during retirement?

Yes \_\_\_ No \_\_\_ Not Sure \_\_\_

Have you sought advice on how to utilize your retirement savings and/or pension?

Yes \_\_\_ No \_\_\_ Not Sure \_\_\_

If you answered “**yes**”, to whom do you turn for advice?

- |  |   |
|--|---|
| <input type="checkbox"/> Professional financial advisor  | <input type="checkbox"/> AARP or other organization |
| <input type="checkbox"/> Elder law professional/attorney | <input type="checkbox"/> Online Resources           |
| <input type="checkbox"/> Family; Friends                 | <input type="checkbox"/> Financial Planning Books   |
| <input type="checkbox"/> Banker                          | <input type="checkbox"/> Other: _____               |

### Did You Know?

Most retirement experts recommend that retirees will need between 70 and 100% of their pre-retirement income to maintain the same standard of living once they stop working. In addition to your Social Security benefits and traditional pension (if any), you can probably spend about 4% of your savings each year.

To know if you'll have enough income in retirement, try to estimate your future expenses, based on what you spend now.

To help get you started, we have provided a set of budgeting worksheets in the back of this workbook.

The National Council on Aging also has a simple tool to help you with budgeting:

#### **Figure Out a Budget in 3 Minutes**

which can be found here:

[www.economiccheckup.org/money-management-tips](http://www.economiccheckup.org/money-management-tips)

# PERSONAL FINANCE

## Understanding Your Expenses: Housing Affordability

Is your monthly mortgage or rent payment so high that you are left without enough money to cover your other monthly expenses? (*note: a monthly mortgage or rent payment that is more than 30% of monthly income is considered unaffordable and can leave you vulnerable if unexpected or emergency expenses come up.*)

Yes \_\_\_ No \_\_\_

If your monthly housing costs are higher than you feel you can afford, have you looked into the pros and cons of any of the following?

- Using your home equity to supplement your income (such as a Home Equity Loan or Reverse Mortgage) (*Buyer beware! Although a reverse mortgage can be very helpful in improving your monthly cash-flow, make sure you research the terms thoroughly before signing. Not all reverse mortgages are the same, and some can be a bad deal.*)
- Refinancing your mortgage at a lower interest rate (*same caveat as above*)
- Property Tax Deferral plan for seniors (if applicable in your state/county)
- Downsizing/Finding a less expensive home
- Remodeling your current home to offer rental space for living or storage
- Adding energy efficiency measures to your home to reduce utility bills
- Home sharing
- Remaining in your current home and reducing your other expenses
- Moving to a lower cost area

Do you know the age of your appliances and other high-cost systems in your home (e.g. roof, heat pump) and their estimated replacement date(s)?

Yes \_\_\_ No \_\_\_ Not Sure \_\_\_

Do you think you will have sufficient funds to repair or replace some of these high-cost systems when needed?

Yes \_\_\_ No \_\_\_ Not Sure \_\_\_

If you answered “**yes**”, what is the source of funds?

\_\_\_\_\_

Have you checked into appliance insurance programs?

Yes \_\_\_ No \_\_\_ Not Sure \_\_\_





# PERSONAL FINANCE

## Documentation

What measures/ legal documents do you have in place?

- Will
- Trust
- Power of attorney
- Advance Medical Directive

Have these documents been updated to reflect your current life preferences/choices/circumstances?

Yes \_\_\_ No \_\_\_ Not Sure \_\_\_

Have you checked into the legal ownership of your assets?

Yes \_\_\_ No \_\_\_ Not Sure \_\_\_

*(Often a deceased spouse or parent will still be listed as the legal owner on titles or deeds. Know who is listed on the title of your primary assets—car, homes, land, stocks, etc.)*

Have you shared the location of these documents and other financial information (e.g. bank accounts, life insurance) with your spouse, children, other family, or trusted friends? Yes \_\_\_ No \_\_\_ Not Sure \_\_\_

If you answered “**yes**”, have you given or written down directions on how access these documents including login and password information? *(checklist provided in additional resources section in the back of this workbook)*

Yes \_\_\_ No \_\_\_ Not Sure \_\_\_

### Did You Know?

Links to helpful financial and legal resources, including information about benefits and supplemental income programs, can be found through:

**The National Council on Aging**

<https://www.ncoa.org/economic-security>

**Senior Navigator**

<http://www.seniornavigator>

**Estate Planning and Document Organizing Tools**

<https://www.everplans.com/digital-estate>

## KEY DOCUMENTS: CREATE THEM, ORGANIZE THEM, SHARE THEM!



### FINANCIAL INFORMATION

Bank and Investment Accounts  
Insurance Documents  
Credit Cards  
Safe Deposit Box  
Storage Locker

with contact details for:  
Accountants  
Financial Planners  
Insurance Agents



### LEGAL INFORMATION

Wills  
Trusts  
Power of Attorney

with contact details for:  
Executors  
Guardians  
Lawyer



### HEALTH INFORMATION

Advance Directive  
Healthcare Proxy  
DNR  
Organ Donation

with contact details for:  
Doctors  
Eldercare Advisors  
Long-Term Care



### PERSONAL INFORMATION

Vital Info  
Funeral Wishes  
Funeral Pre-Planning  
Message To Family  
Pets

Ethical Will  
Home Utilities  
Online Accounts

with contact details for:  
Emergency Contacts



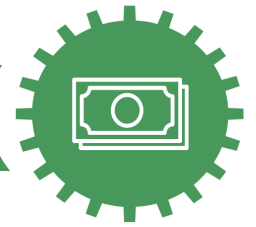

## MY PLAN FOR PERSONAL FINANCE

My “Plan A” for personal finance, i.e. my ideal aging in place scenario is:

---

---

---

---

My “Plan B” for personal finance if my financial, physical, or health circumstances change:

---

---

---

---

Actions I will take to make my “Plan A” probable and my “Plan B” possible:

Keep Doing

---

---

---

---

---

---

---

---

Start Doing

---

---

---

---

---

---

---

---



## CONNECTION & GROWTH





# CONNECTION & GROWTH

## Planning for Aging In Place—Key Points on Connection & Growth

### #1: SEE THE WHOLE WELLNESS PICTURE

As you make choices in your life consider these additional dimensions of wellness:

- *Emotional wellness* encompasses optimism, self-esteem, self-acceptance, and the ability to share feelings. It includes the capacity to manage one's feelings and related behaviors including the realistic assessment of one's limitations and the ability to cope effectively with stress. It's also important to think about mental health challenges that can occur later in life. While mental health problems are not considered a normal part of aging, there are a number of risk factors that older adults should be aware of. Poor mental health can have cascade effects on other areas of life as well, from physical health to your ability to manage day-to-day tasks, so this should not be overlooked or dismissed.
- *Intellectual wellness* refers to keeping your mind active and continuing to learn. Our minds need to be inspired and exercised just like our bodies do.
- *Spiritual wellness* involves possessing a set of guiding beliefs, principles, or values that help give direction to one's life, providing a sense of meaning and purpose.

### #2: BE AWARE OF THE RISK FACTORS FOR SOCIAL ISOLATION

Social isolation is a significant predictor of poor physical and emotional health outcomes in older adults. When changes occur in our life, we may not fully realize how they will affect our ability to stay connected to other people. If we are aware of the risk factors for social isolation, we can be proactive and not slip into an unhealthy pattern.

The three top-ranked risk factors for social isolation are living alone; having a mobility or sensory impairment; or experiencing major life transitions or losses such as divorce, retirement, moving to a new place, or the death of someone close to you. If several risk factors occur simultaneously, the impact can be much greater.

### #3: BUILD AND DIVERSIFY YOUR SOCIAL RESOURCES

Think about all the ways your social connections are beneficial to your life. Your social network is a source of emotional support, a source of information, and a source of help. It is never too late to work on improving your social resources: strengthening the relationships you have as well as forging new ones.

# CONNECTION & GROWTH

## Opportunities for Social Interaction

Do you feel that you have enough social interaction with other people?

Yes \_\_\_ No \_\_\_ Not Sure \_\_\_

If you answered “no”:

What are the reasons? *Select all that apply.*

- Transportation (hard to drive at night, cost, etc.)
- Home is far away from social opportunities
- Children/family no longer live in the area
- Don't feel connected to people or groups in the area
- Other: \_\_\_\_\_

### Did You Know?

Isolation and loneliness are associated with higher rates of chronic health conditions, weakened immune system, depression, anxiety, and dementia.

Are the social activities and entertainment that you prefer, available in your community?

Yes \_\_\_ No \_\_\_ Not Sure \_\_\_

If you answered “no”:

What kind of social activities and entertainment would you be interested in?

- Theatre
- Exercise
- Civic and Service groups/clubs
- Religious or Spiritual groups
- Craft Clubs or Guilds
- Dance
- Music
- Movies
- Book Clubs or Writer's Groups
- Speakers and Adult Education
- Sports and/or Recreation
- Other: \_\_\_\_\_



# CONNECTION & GROWTH

## Opportunities for Social Interaction

Do you feel connected to your local community?

Yes \_\_\_ No \_\_\_ Not Sure \_\_\_

Would you like to volunteer in your community?

Yes \_\_\_ No \_\_\_ Not Sure \_\_\_

Do you participate in events at senior centers?

Yes \_\_\_ No \_\_\_

Are you a member of or do you belong to any religious institutions, clubs, local groups, alumni associations, etc.?

Yes \_\_\_ No \_\_\_

If you are not as involved in your community as you would like to be, is there a reason?

(Select all that apply)

- Do not have funds
- Physical limitations/health challenges
- Limited transportation options
- Not sure where to start
- Not enough time/other commitments
- Others: \_\_\_\_\_

How comfortable are you using technologies (smart phones, tablets, computers)?

- Not comfortable at all
- Moderately comfortable
- Very comfortable

Would you consider a course on using these technologies if it could help you feel more connected?

Yes \_\_\_ No \_\_\_ Not Sure \_\_\_

### Did You Know?

Volunteering is a great way to help others in community and stay connected to others. There are many volunteer opportunities for sharing your skills, talents, and life experience. In addition to traditional options such as hospitals, libraries, and museums, here are a few options you may not be aware of:

Retired Senior Volunteer Corps  
(RSVP)

[www.nationalservice.gov/  
programs/senior-corps/](http://www.nationalservice.gov/programs/senior-corps/)

The National Resource Center for  
Engaging Older Adults

[engagingolderadults.org](http://engagingolderadults.org)



# CONNECTION & GROWTH

## Opportunities for Fulfilling Activities

Do you have enough opportunities to do things that interest and/or challenge you?

Yes \_\_\_ No \_\_\_ Not Sure \_\_\_

If you answered “no”:

What interests would you like to pursue? (Select all that apply)

- |   |   |
|---|---|
| <input type="checkbox"/> Gardening                              | <input type="checkbox"/> Carpentry/Woodworking                  |
| <input type="checkbox"/> Games (solo or with friends)           | <input type="checkbox"/> Hunting/Fishing                        |
| <input type="checkbox"/> Reading or writing                     | <input type="checkbox"/> Camping/Hiking                         |
| <input type="checkbox"/> Visual Art or Crafts                   | <input type="checkbox"/> Outdoor Hobbies, i.e. birding          |
| <input type="checkbox"/> Music or other Performing Arts         | <input type="checkbox"/> Genealogy/History                      |
| <input type="checkbox"/> Charitable or Civic Work               | <input type="checkbox"/> Solo exercise (i.e. cycling, swimming) |
| <input type="checkbox"/> Competitive Activities                 | <input type="checkbox"/> Group exercise, classes, or sports     |
| <input type="checkbox"/> Touring/Travel                         | <input type="checkbox"/> Car Repair/Restoration                 |
| <input type="checkbox"/> Classes (Lifelong Learning Institutes) | <input type="checkbox"/> Other: _____                           |

Do you enjoy traveling either internationally or domestically? Yes \_\_\_ No \_\_\_

Are you able to travel as much as you would like?

Yes \_\_\_ No \_\_\_ Not Sure \_\_\_

If you answered “no” or “not sure”:

What is preventing you?

- Physical limitations and /or health challenges
- Finances
- Lack of a travel partner
- Lack information on travel options
- Other: \_\_\_\_\_





# CONNECTION & GROWTH

## Mental Health Awareness

Some of the changes and challenges often encountered in later life (e.g., deteriorating health, caregiving responsibilities) can significantly impact one's mental health and the ability to successfully age in place. Please review the list of circumstances below and select any that apply to you.

- Increased or significant caregiving responsibilities.
- Serious or long-term illness (yourself or another person close to you).
- Recent loss of spouse, close family member, or close friend (or other grief/loss).
- Recent change of environment, i.e. moving.
- Physical disability that limits your mobility or ability to function.

Consider seeking treatment if you are experiencing one or more of the following:

- Persistent worry about issues such as money, family, health, or the future.
- Reduced interest in maintaining personal appearance or daily housekeeping chores.
- Increased alcohol intake and/or taking more medication than prescribed.
- Lack of interest in being around other people or activities that used to be enjoyable for you.
- Feeling confused, disoriented, or having problems making decisions.
- Feeling hopeless or worthless, or having thoughts about harming yourself.

### Did You Know?

One in five older adults struggle with mental health conditions, with the most common being anxiety or depression. Here are a some things to keep in mind:

- Although struggles with mental health are not a normal part of aging, there are some particular risk factors that older adults may face with greater frequency such as the loss of a spouse or serious health challenges.
- Signs of untreated mental health issues often include fatigue, social isolation, slower healing from illness, and drug and alcohol misuse; all of which directly affect physical health, the ability to perform daily activities, life satisfaction, and quality of life.
- Sudden signs of poor mental health can also signal an underlying problem such as stroke, dementia, an adverse reaction to or between medications.
- With treatment and support, older adults with mental health challenges can be helped with great success.



# CONNECTION & GROWTH



## MY PLAN FOR CONNECTION & GROWTH

My “Plan A” for connection & growth, i.e. my ideal aging in place scenario is:

---

---

---

---

My “Plan B” for connection & growth, if my financial, physical or health circumstances change:

---

---

---

---

Actions I will take to make my “Plan A” probable and my “Plan B” possible:

Keep Doing

---

---

---

---

---

---

---

---

Start Doing

---

---

---

---

---

---

---

---



## ADDITIONAL RESOURCES





# PERSONAL PLAN DEVELOPMENT CHECKLISTS

## UNDERSTANDING YOUR PRIORITIES: DEVELOPING YOUR PLAN

Congratulations! You've made it through all five sections and have jotted down key questions, considerations, and priorities for each topic as well as your Plan A and Plan B for each topic area. Now it's time to identify items that need further research and attention. Please use the spaces provided in the next few pages to create a personalized checklist. We encourage you to review and discuss this list with your family, friends, doctors, financial planners and others who are important to making your aging in place plan a reality. Note: you can download and customize all the forms and checklists in this section on the Aging In Place website at: [nrvaoo.org/aging-in-place](http://nrvaoo.org/aging-in-place)

### DISCUSSIONS I WANT TO HAVE WITH FAMILY AND OTHERS:

- \_\_\_\_\_
- \_\_\_\_\_
- \_\_\_\_\_
- \_\_\_\_\_
- \_\_\_\_\_
- \_\_\_\_\_
- \_\_\_\_\_
- \_\_\_\_\_

### PROFESSIONAL SERVICES OR OUTSIDE EXPERTISE I MAY NEED:

- \_\_\_\_\_
- \_\_\_\_\_
- \_\_\_\_\_
- \_\_\_\_\_
- \_\_\_\_\_
- \_\_\_\_\_

# PERSONAL PLAN DEVELOPMENT CHECKLISTS

## LEGAL ACTIONS OR DOCUMENTS I WANT TO PURSUE/CREATE:

- \_\_\_\_\_
- \_\_\_\_\_
- \_\_\_\_\_
- \_\_\_\_\_
- \_\_\_\_\_
- \_\_\_\_\_
- \_\_\_\_\_
- \_\_\_\_\_
- \_\_\_\_\_
- \_\_\_\_\_

## OTHER ITEMS I WANT TO TACKLE:

- \_\_\_\_\_
- \_\_\_\_\_
- \_\_\_\_\_
- \_\_\_\_\_
- \_\_\_\_\_
- \_\_\_\_\_
- \_\_\_\_\_
- \_\_\_\_\_
- \_\_\_\_\_
- \_\_\_\_\_

# PERSONAL PLAN DEVELOPMENT CHECKLISTS

## IMPORTANT DOCUMENTS/INFORMATION LIST:

## HOW TO ACCESS/CONTACT THEM:

<input type="checkbox"/> Will or Trust	<input type="checkbox"/> _____
<input type="checkbox"/> Power of Attorney	<input type="checkbox"/> _____
<input type="checkbox"/> Bank & Investment Accounts	<input type="checkbox"/> _____
<input type="checkbox"/> List of Property/Assets	<input type="checkbox"/> _____
<input type="checkbox"/> Safe, Safe Deposit Box or Storage	<input type="checkbox"/> _____
<input type="checkbox"/> Insurance Documents	<input type="checkbox"/> _____
<input type="checkbox"/> Advance Directive and/or Living Will	<input type="checkbox"/> _____
<input type="checkbox"/> Healthcare Proxy and/or DNR	<input type="checkbox"/> _____
<input type="checkbox"/> Organ Donation	<input type="checkbox"/> _____
<input type="checkbox"/> Vital Health Information	<input type="checkbox"/> _____
<input type="checkbox"/> Funeral Wishes, Message to Family	<input type="checkbox"/> _____
<input type="checkbox"/> Funeral Pre-Planning	<input type="checkbox"/> _____
<input type="checkbox"/> Wishes/Directions for Pets	<input type="checkbox"/> _____
<input type="checkbox"/> Recurring Bills (Utilities, etc.)	<input type="checkbox"/> _____
<input type="checkbox"/> Credit Cards	<input type="checkbox"/> _____
<input type="checkbox"/> Online Accounts (login/passwords)	<input type="checkbox"/> _____
<input type="checkbox"/> Pension, Social Security	<input type="checkbox"/> _____
<input type="checkbox"/> Emergency Contacts	<input type="checkbox"/> _____
<input type="checkbox"/> Financial Professionals	<input type="checkbox"/> _____
<input type="checkbox"/> Healthcare Professionals	<input type="checkbox"/> _____
<input type="checkbox"/> Legal Professionals	<input type="checkbox"/> _____

# BUDGET PLANNING WORKSHEETS

<b>INCOME: Monthly</b>	<b>CURRENT</b>	<b>RETIREMENT</b>
Wages, salary, tips		
Cash dividends		
Interest received		
Social Security		
Pension income		
Rents, royalties		
Other income:		
Other income:		
Total Monthly Income		
<b>TAXES/ADJUSTMENTS: Monthly</b>		
Federal income taxes		
State income taxes		
FICA - SSA		
Other taxes		
Total Monthly Taxes		

Total Monthly Income		
(Subtract) Total Monthly Taxes		
<b><i>Total Adjusted Monthly Income</i></b>		



# BUDGET PLANNING WORKSHEETS

<b>FIXED EXPENSES: Monthly</b>	<b>CURRENT</b>	<b>RETIREMENT</b>
Mortgage payment or rent		
2nd home mortgage		
Real estate taxes		
Automobile loan		
Personal loans		
Life insurance		
Disability insurance		
Medical insurance		
Long-term care insurance		
Homeowner's insurance		
Automobile insurance		
Umbrella liability insurance		
Savings (regular)		
Investments (regular)		
Retirement plan contributions		
Other:		
Other:		
Other:		
Other:		
Other:		
<b>Total Fixed Expenses</b>		

# BUDGET PLANNING WORKSHEETS

<b>VARIABLE EXPENSES: Monthly</b>	<b>CURRENT</b>	<b>RETIREMENT</b>
Electricity		
Gas/Fuel		
Telephone		
Water		
Cable TV/Streaming Subscriptions		
Home Repairs/Maintenance		
Landscaping		
Credit cards -- total		
Food/Dining		
Clothing/Laundry		
Camp/Child care		
Personal care		
Other family care expenses		
Automobile gas & oil		
Automobile repairs, etc.		
Other transportation		
Education expenses		
Entertainment		
Recreation/Travel		
Club/Association dues		
Hobbies		
Gifts/Donations		
Unreimbursed medical/dental		
Pets		
Other:		
Other:		
Other:		
Other:		
Other:		
<b><i>Total Variable Monthly Expenses</i></b>		



# HOME MAINTENANCE CHECKLISTS

Deferred home maintenance can lead to expensive or even dangerous conditions over time and may diminish your ability to successfully age in place. Not everyone will feel comfortable performing each of the tasks listed below; it may be worth hiring a professional to do some of them. You may find it helpful to use a highlighter to identify those tasks you are considering hiring out (or having a volunteer, neighbor or family member do for you). Since each of these tasks should be done annually you may want to print a paper copy and date it for each calendar year. You can download these checklists from the Aging In Place website ([nrvaoo.org/aging-in-place](http://nrvaoo.org/aging-in-place)) and customize them for the tasks that are particular to your home or property.

*(Note: If you are unfamiliar with some of these items, YouTube can be a great resource to find step-by-step instructions for even the smallest home maintenance tasks.)*

## Spring List: March, April, May

Year \_\_\_\_\_

- Inspect and replace HVAC (Heating, Ventilation, and Air Conditioning)/furnace filters
- Clean kitchen exhaust hood and filter
- Install fresh batteries in smoke and carbon monoxide detectors
- Test and dust all detectors
- Inspect bathroom and kitchen caulk; recaulk as needed
- Vacuum refrigerator coils
- Schedule air conditioning inspection (if relevant)
- Check fire extinguishers
- Remove storm windows, and install screens
- Repair/replace damaged window screens
- Prune spring-flowering shrubs after they bloom
- Prune summer-flowering shrubs before they bloom
- Schedule yearly septic tank inspection (if relevant)
- \_\_\_\_\_
- \_\_\_\_\_
- \_\_\_\_\_
- \_\_\_\_\_
- \_\_\_\_\_

# HOME MAINTENANCE CHECKLISTS

## Summer List: June, July, August

Year \_\_\_\_\_

- Inspect and replace HVAC (Heating, Ventilation, and Air Conditioning)/furnace filters
- Clean kitchen exhaust hood and filter
- Have the roof inspected for damage
- Have the attic inspected for water damage or roof leaks
- Inspect outdoor structures for stability (sheds, outbuildings, gazebo)
- Inspect exterior paint and touch up as needed
- Inspect siding/masonry for damage
- Have the gutters cleaned (consider installing gutter guards)
- Clean and seal deck (if needed)
- Vacuum refrigerator coils
- Reverse direction of ceiling fans (to blow cool air downward)
- Inspect foundation for drainage problems (clogged downspouts, grading issues, etc.)
- Inspect basement/crawl space for moisture issues
- Inspect for insect activity (termites, ants, wood bees, etc.)
- \_\_\_\_\_
- \_\_\_\_\_
- \_\_\_\_\_
- \_\_\_\_\_
- \_\_\_\_\_
- \_\_\_\_\_
- \_\_\_\_\_
- \_\_\_\_\_
- \_\_\_\_\_
- \_\_\_\_\_
- \_\_\_\_\_
- \_\_\_\_\_
- \_\_\_\_\_
- \_\_\_\_\_
- \_\_\_\_\_
- \_\_\_\_\_
- \_\_\_\_\_
- \_\_\_\_\_

# HOME MAINTENANCE CHECKLISTS

## Fall List: September, October, November

Year \_\_\_\_\_

- Inspect and replace HVAC (Heating, Ventilation, and Air Conditioning)/furnace filters
- Install fresh batteries in smoke and carbon monoxide detectors
- Test and dust all detectors
- Check fire extinguishers
- Clean kitchen exhaust hood and filter
- Drain sediment from hot water heater
- Vacuum refrigerator coils
- Insulate exposed pipes as needed
- Schedule furnace inspection
- Remove (or cover) window air conditioners (if relevant)
- Have chimneys and flues inspected and cleaned (if relevant)
- Remove screens and install storm windows
- Turn off outdoor water supply, and store hoses
- Have the roof inspected for damage
- Have the gutters cleaned
- Inspect caulk around windows and doors; re-caulk as needed
- Trim trees and shrubs away from house
- Inspect deck for any nails or screws that may be popping up
- Cover or store outdoor furniture
- \_\_\_\_\_
- \_\_\_\_\_
- \_\_\_\_\_
- \_\_\_\_\_
- \_\_\_\_\_
- \_\_\_\_\_
- \_\_\_\_\_
- \_\_\_\_\_
- \_\_\_\_\_



# ACKNOWLEDGEMENTS

We hope you have found this Aging In Place Planning Workbook helpful. The content was compiled and adapted by the New River Valley Aging In Place Leadership Team based in Blacksburg, Virginia. This group is dedicated to creating lifespan friendly communities, and is made up of individuals from agencies and organizations across the New River Valley region, including:

**Nancy Brossoie**, Senior Research Scientist, Virginia Tech Center for Gerontology

**Carol Davis**, Sustainability Manager, Town of Blacksburg

**Patti Drescher**, Occupational Therapist, Virginia Department for Aging & Rehabilitative Services

**Shelley Fortier**, Executive Director, Habitat for Humanity of the New River Valley

**Pat Hyer**, Community Member and Aging Advocate, Lifelong Learning Institute at Virginia Tech and Blacksburg AARP

**Lorrie Jufes**, Community Member and Aging Advocate, New River Valley

**Tina King**, Executive Director, New River Valley Area Agency on Aging

**Anne McClung**, Planning & Building Director, Town of Blacksburg

**Jerry Niles**, Community Member and Aging Advocate, Lifelong Learning Institute at Virginia Tech and Blacksburg AARP

**Ellen Stewart**, Housing & Community Development Grants Coordinator, Town of Blacksburg/New River Valley HOME Consortium

**Kim Thurlow**, Community Programs Director, Community Foundation of the New River Valley

**Elisabeth Willis**, Senior Housing & Community Development Project Manager, Town of Blacksburg/New River Valley HOME Consortium

**Jennifer Wilsie**, Senior Planner, New River Valley Regional Commission

**Jessica Wirgau**, Executive Director, Community Foundation of the New River Valley

## Fair Use Notice

This workbook has been produced for non-profit, educational purposes. It may contain certain material for which the copyright holder is unknown. We are making this workbook and any such material available at cost for educational (and not commercial) purposes as part of our efforts to assist older adults to age in place in order to improve quality of life. We believe this constitutes a 'fair use' of any such copyrighted material as provided for by the Copyright Act. Please contact [housing@blacksburg.gov](mailto:housing@blacksburg.gov) for information.



